

Maswell 5G Combination Antenna

4X4MIMO 5G and GNSS

AN_Master_Cubic_4C1GN-LP



Schematic picture

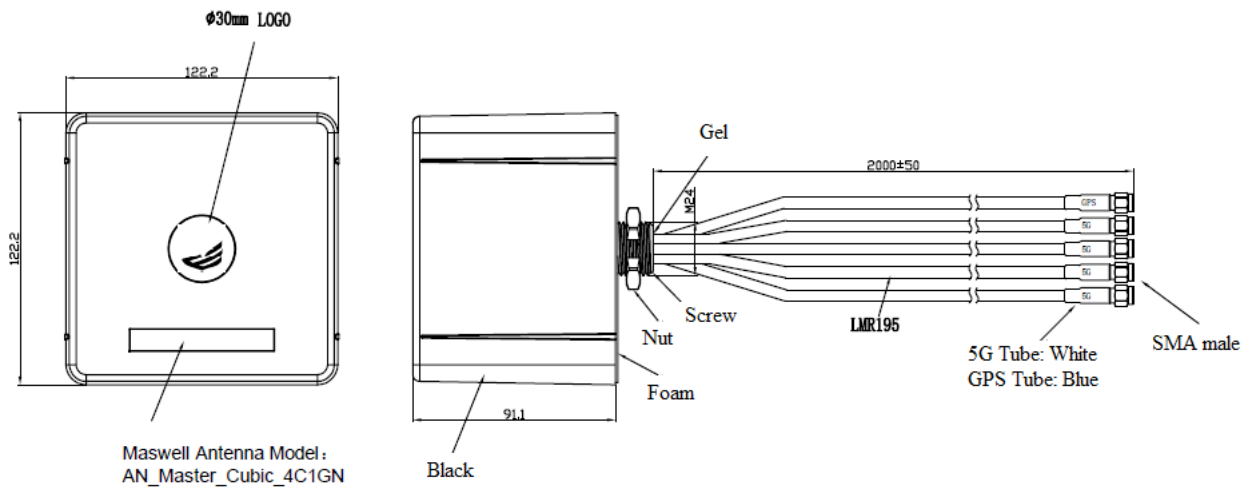

Maswell 5G Combination Antenna

4X4MIMO 5G and GNSS

AN_Master_Cubic_4C1GN-LP

Specifications

Item		Specifications	
GNSS Antenna (GPS/GLONASS/ Beidou/Gaileo)	Dielectric Antenna	Center Frequency	1561.098~1602MHz
		Polarization	RHCP
		Gain	5dBic@PCB (Zenith)
		V.S.W.R	< 1.5
		Impedance	50Ω
		Axial Ratio	3dB(max)
	LNA	Gain	28±2dB
		Noise Figure	≤1.5dB
		Filter Insertion Loss	< 3dB
		Supply Voltage	3~5V DC
		Current Consumption	< 20mA
		V.S.W.R	< 2.0
Antenna 1: 5G/4G LTE/WiFi6E/UWB	Frequency Range	600MHz~8.0GHz	
	Polarization	Linear	
	Gain	Up to 6.0 dBi (20cm cable length)	
	V.S.W.R	average 3.0	
	Efficiency	> 50%	
Antenna 2: 5G/4G LTE/WiFi6E/UWB	Frequency Range	600MHz~8.0GHz	
	Polarization	Linear	
	Gain	Up to 6.0 dBi (20cm cable length)	
	V.S.W.R	average 3.0	
	Efficiency	> 50%	

Maswell 5G Combination Antenna

4X4MIMO 5G and GNSS

AN_Master_Cubic_4C1GN-LP

Specifications

Item	Specifications	
Antenna 3: 5G/4G LTE/WiFi6E/UWB	Frequency Range	600MHz~8.0GHz
	Polarization	Linear
	Gain	Up to 6.0 dBi (20cm cable length)
	V.S.W.R	average 3.0
	Efficiency	>50%
Antenna 4: 5G/4G LTE/WiFi6E/UWB	Frequency Range	600MHz~8.0GHz
	Polarization	Linear
	Gain	Up to 6.0 dBi (20cm cable length)
	V.S.W.R	average 3.0
	Efficiency	>50%
Mechanical	Dimension	122mm *122mm*91mm
	Cable	LMR195 2meter or Customised
	Mounting Method	L plate (Supplied) U bolt and Screw
	Connector	SMA Male for 5G MIMO SMA male for GNSS
Environmental	Operating Temperature	-40°C ~ +85°C
	Waterproof Grade	IP 67
	Relative Humidity	Up to 95%
	Vibration	10 to 55Hz with 1.5mm amplitude 2hours
	Environmentally Friendly	ROHS Compliant

Maswell 5G Combination Antenna

4X4MIMO 5G and GNSS

AN_Master_Cubic_4C1GN-LP

5G S11 Reflection Coefficient

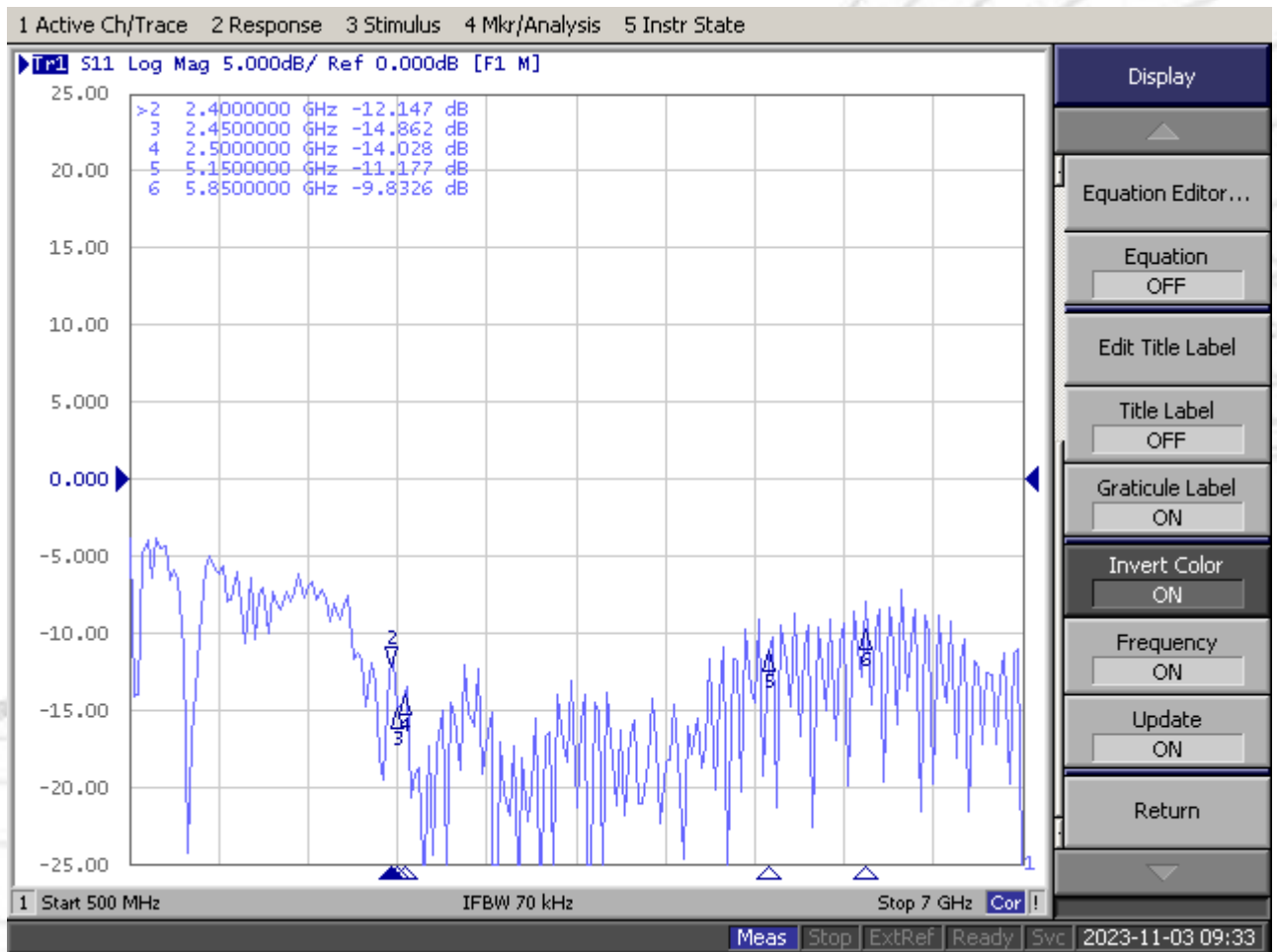

Maswell 5G Combination Antenna

4X4MIMO 5G and GNSS

AN_Master_Cubic_4C1GN-LP

GNSS S11 Reflection Coefficient

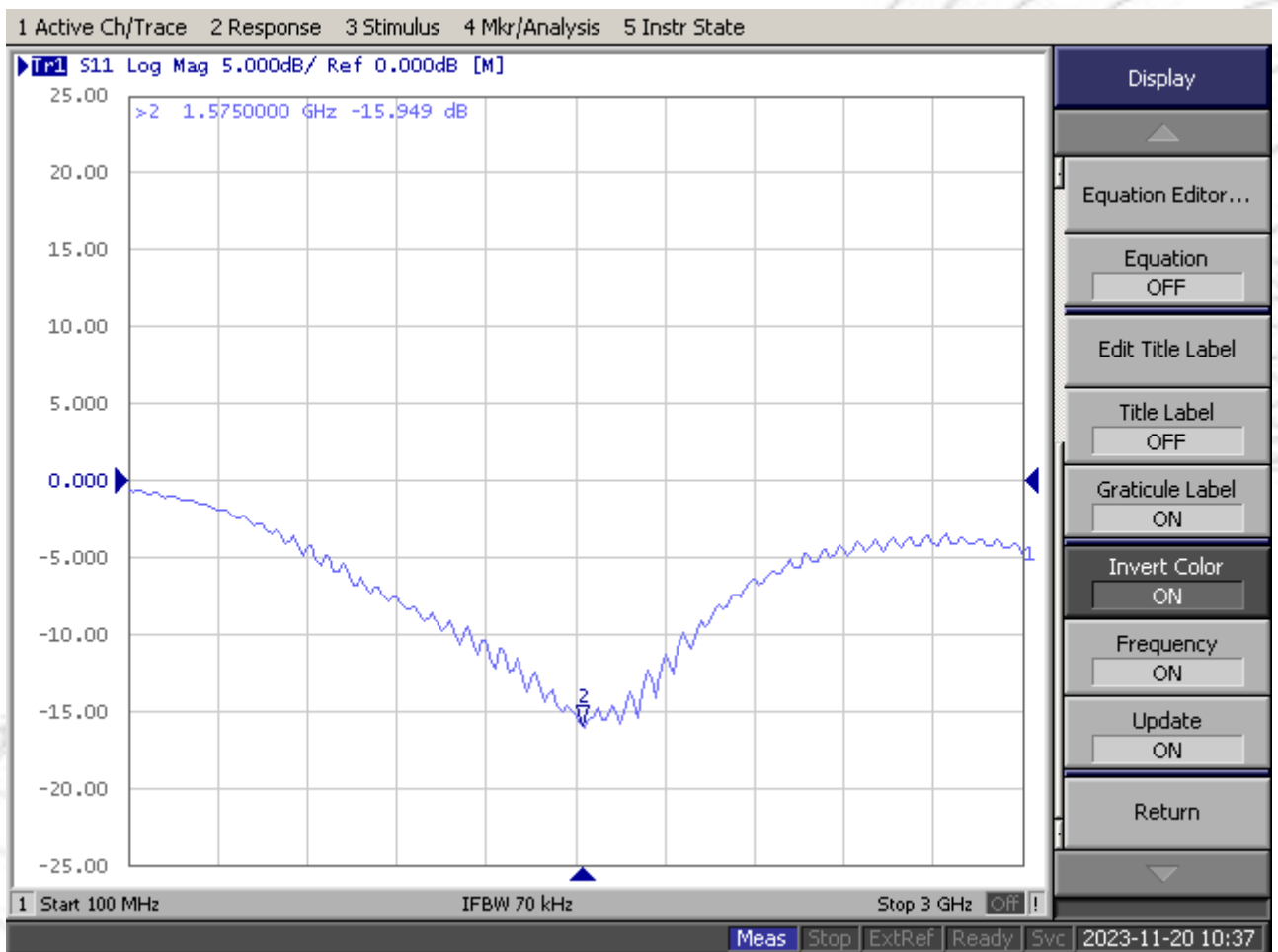

Maswell 5G Combination Antenna

4X4MIMO 5G and GNSS

AN_Master_Cubic_4C1GN-LP

Isolation

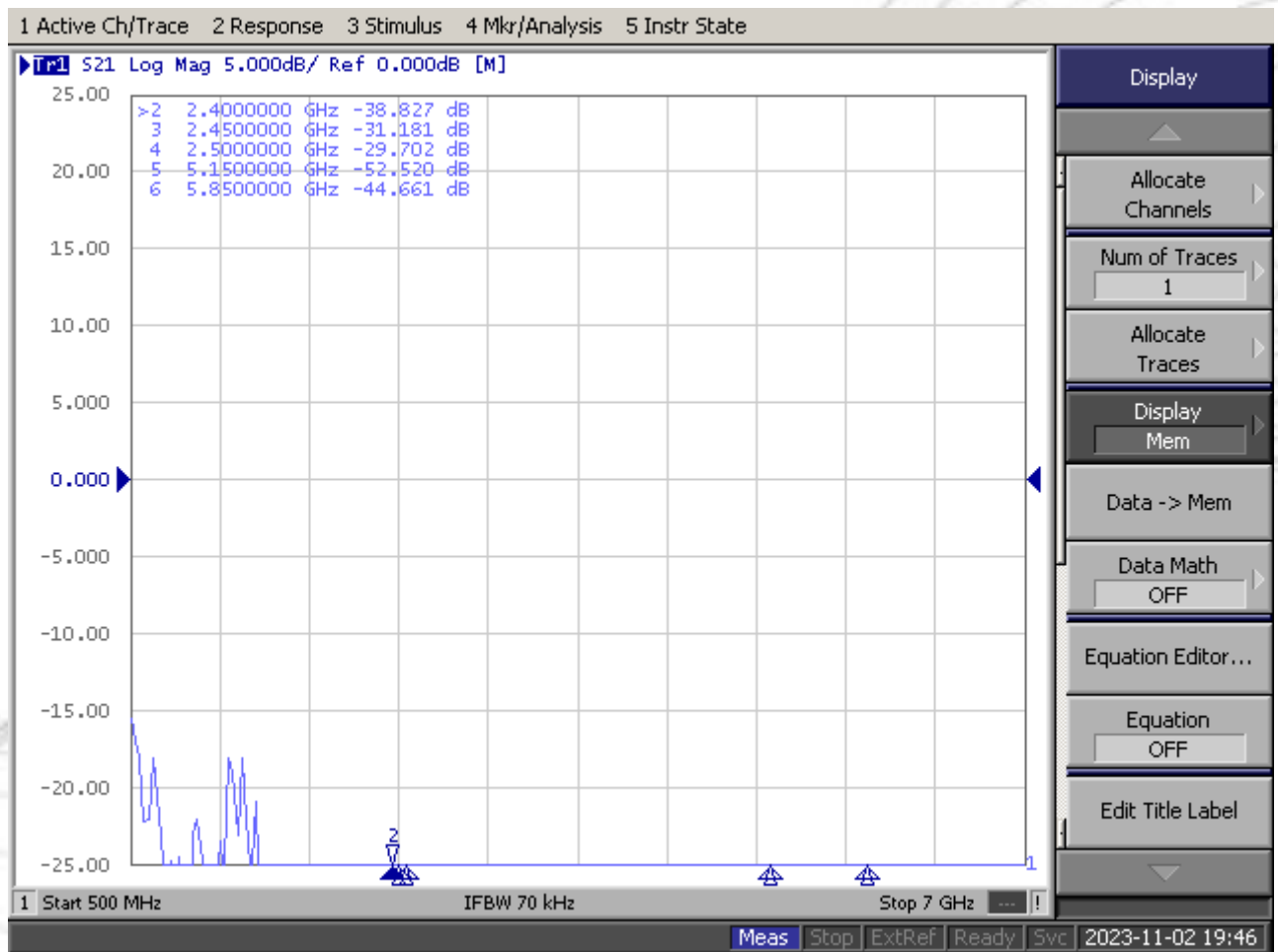

Maswell 5G Combination Antenna

4X4MIMO 5G and GNSS

AN_Master_Cubic_4C1GN-LP

Radiation Pattern

900HMz

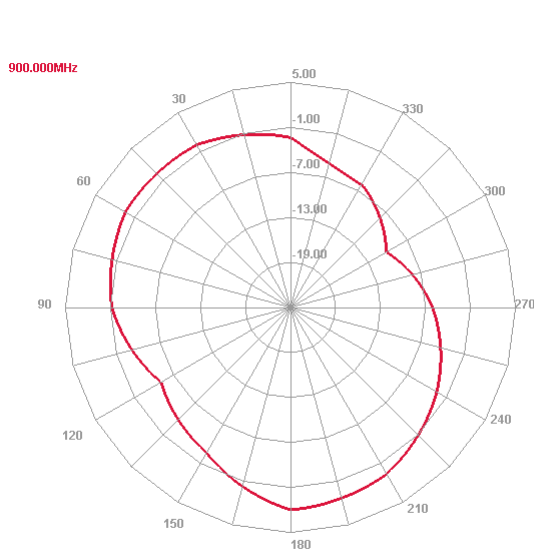

E plane

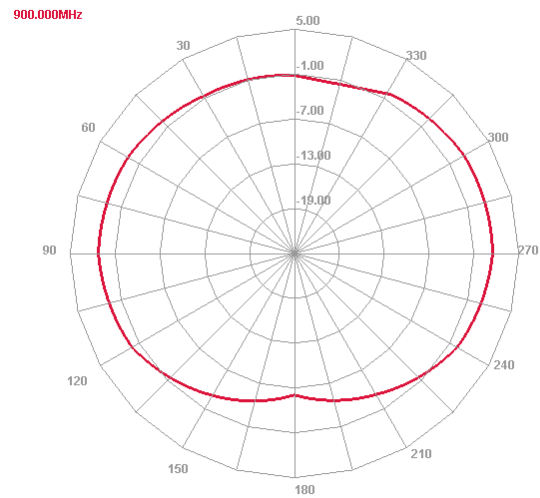

H plane

2400HMz

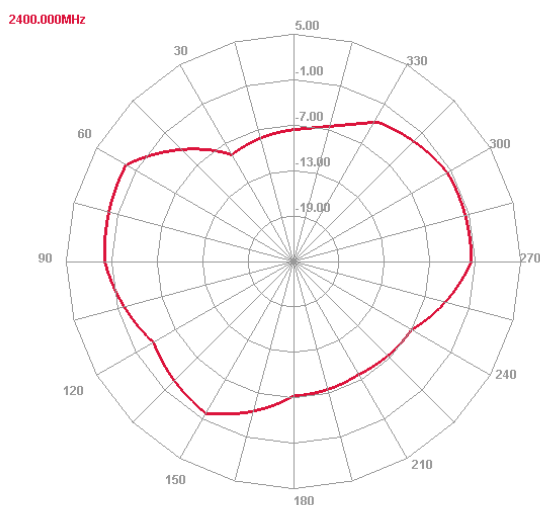

E plane

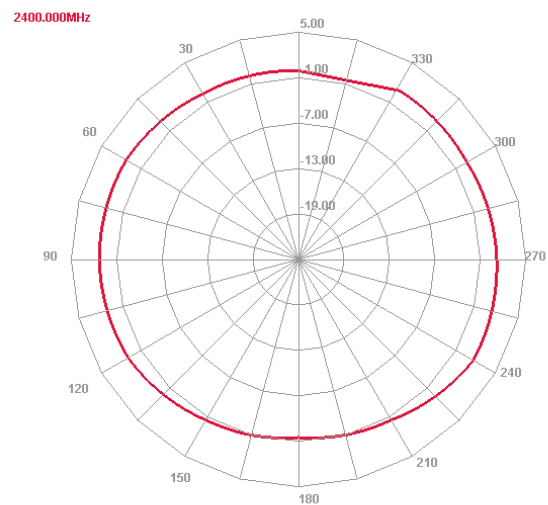

H plane

Maswell 5G Combination Antenna

4X4MIMO 5G and GNSS

AN_Master_Cubic_4C1GN-LP

Radiation Pattern

3500MHz

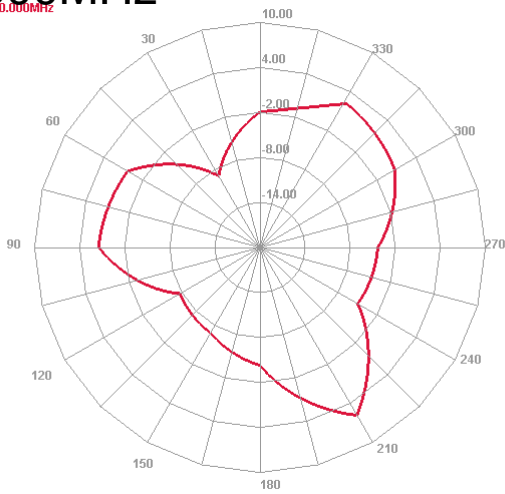

E plane

3500.000MHz

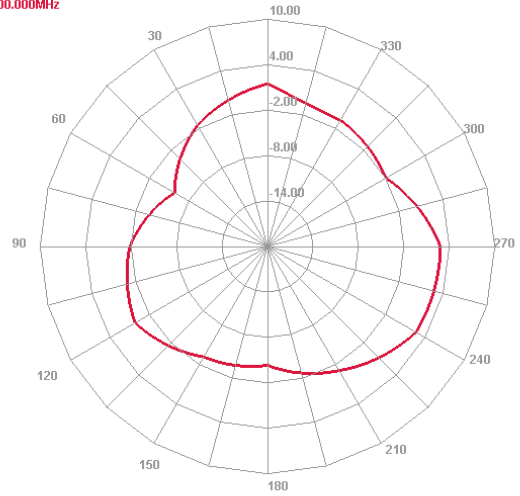

H plane

7100MHz

7100.000MHz

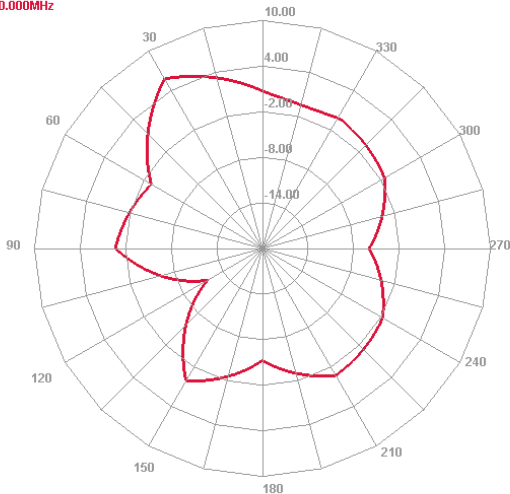

E plane

7100.000MHz

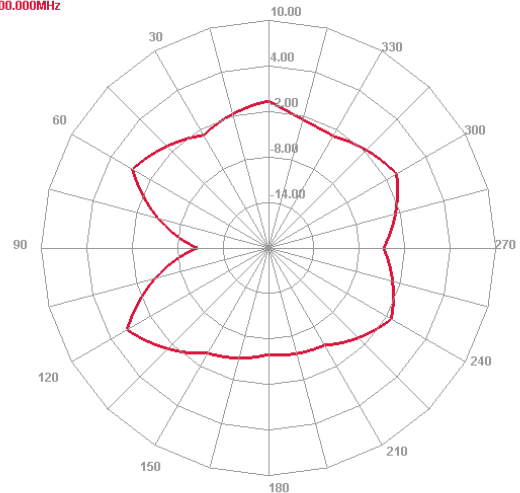

H plane