

Maswell 5G/4G/LTE+GPS Panel Combo Antenna

AN_Master_001-3

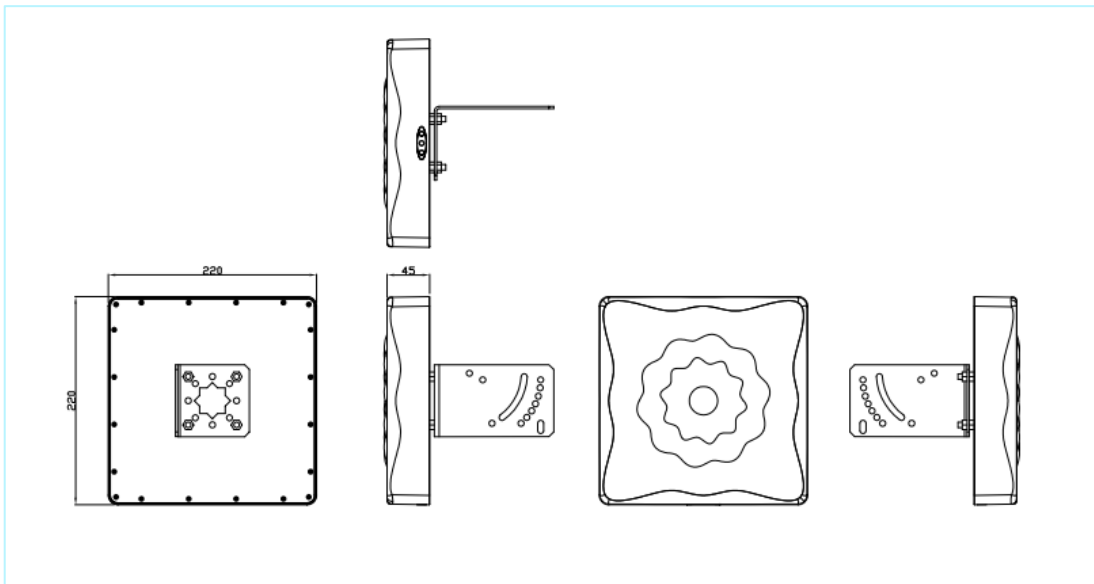

Mechanical dimension



Maswell 5G/4G/LTE+GPS Panel Combo Antenna

AN_Master_001-3

Specifications

Item	Specifications	
5G Antenna	Frequency Range	600-6000MHz
	Polarization	Linear
	Gain	6.0dBi
	V.S.W.R	< 2.0
	Impedance	50Ω
	Isolation	15dB
GPS Antenna	Center Frequency	1575.42 ± 3MHz
	Polarization	RHCP
	Gain	6.0dBi
	V.S.W.R	< 2.0
	Impedance	50Ω
	Isolation	15dB
Mechanical	Dimension	22cm*22cm*4.5cm
	Cable	Customizable
	Connector	SMA or others
	Mounting Method	Screw U bolt
Environmental	Operating Temperature	-40°C~+85°C
	Vibration	10 to 55Hz with 1.5mm amplitude 2hours
	Environmentally Friendly	ROHS Compliant

- ◆ Support all 5g, 4G, 3G, GSM and dual band WiFi bands in the world!
- ◆ Single antenna meets all wireless protocol needs, no need to buy other antenna!
- ◆ Up to 6dbi gain for various signal transmitting and receiving scenarios!

Suzhou maswell communication technology co. Ltd

Add: Floor 3, Building 6, No. 88 Zhenbei Road, High-tech District, Suzhou 215153, Jiangsu, China

Http://www.maswelltech.com

E-mail: Sales@maswelltech.com

Maswell 5G/4G/LTE+GPS Panel Combo Antenna

AN_Master_001-3

Experimental results:

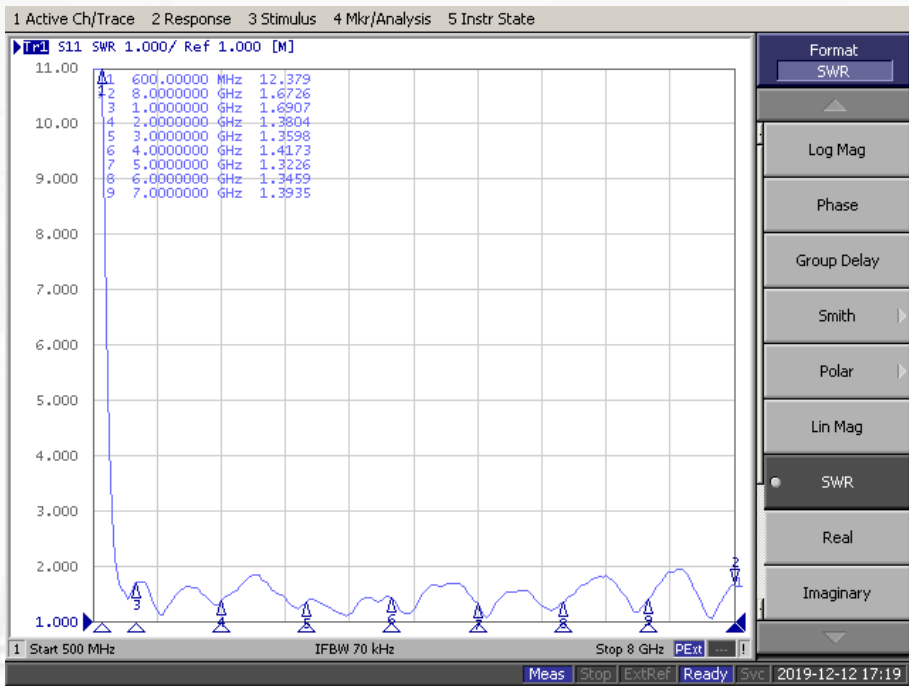

Measured VSWR

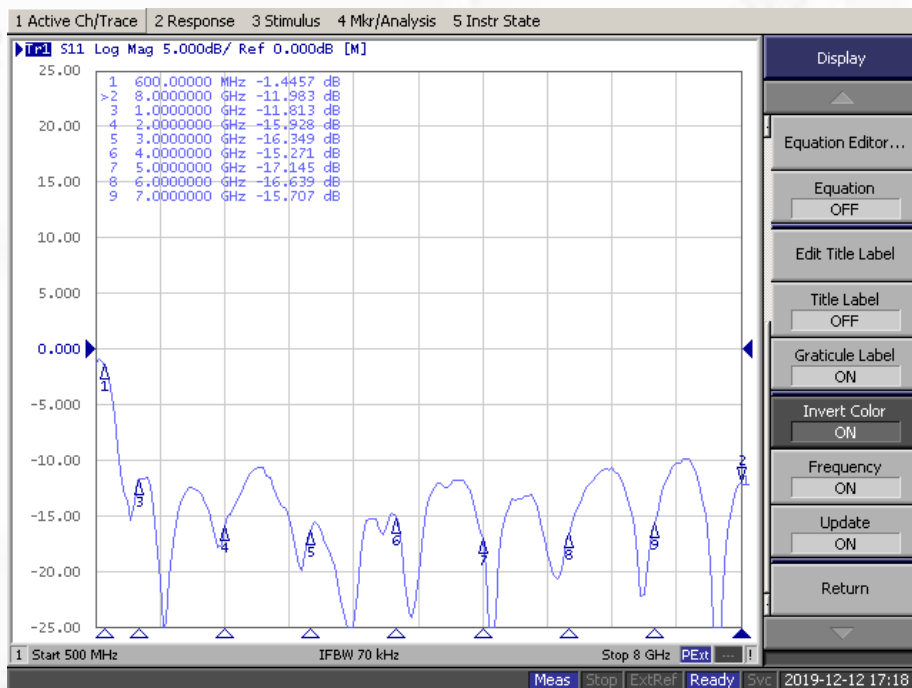

Measured S11

Maswell 5G/4G/LTE+GPS Panel Combo Antenna

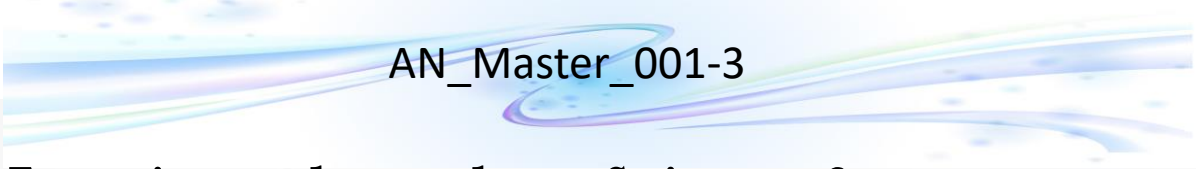

Experimental results: Gain performance

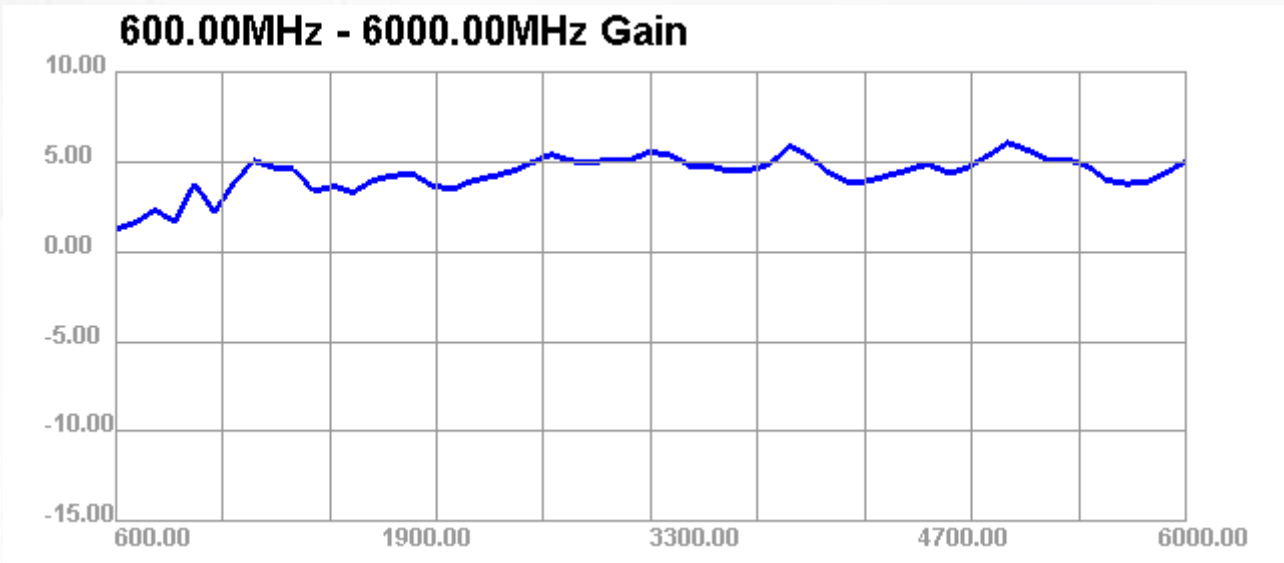

Measurement gain curve

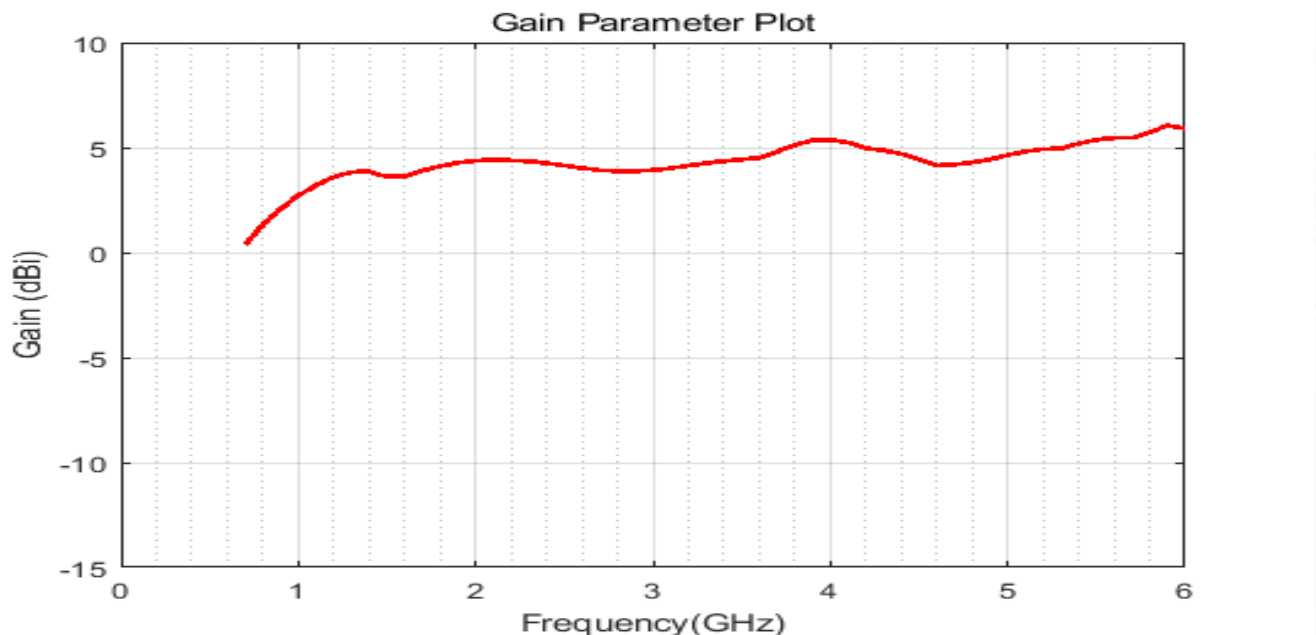

Simulation gain curve

Maswell 5G/4G/LTE+GPS Panel Combo Antenna

AN_Master_001-3

Radiation pattern: low frequency

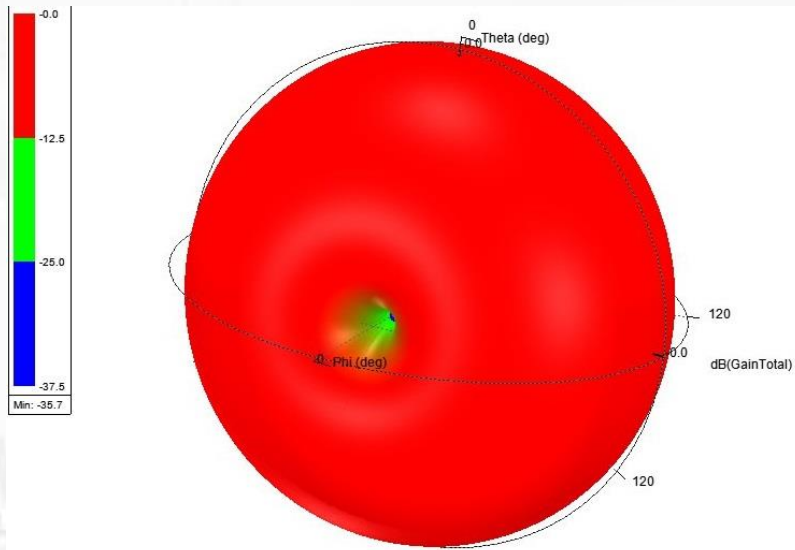

600 MHz

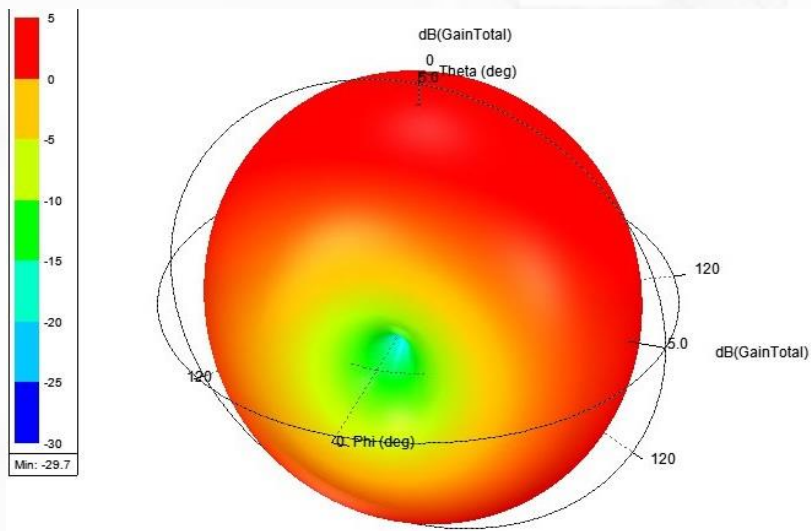

900 MHz

Maswell 5G/4G/LTE+GPS Panel Combo Antenna

AN_Master_001-3

Radiation pattern: intermediate frequency

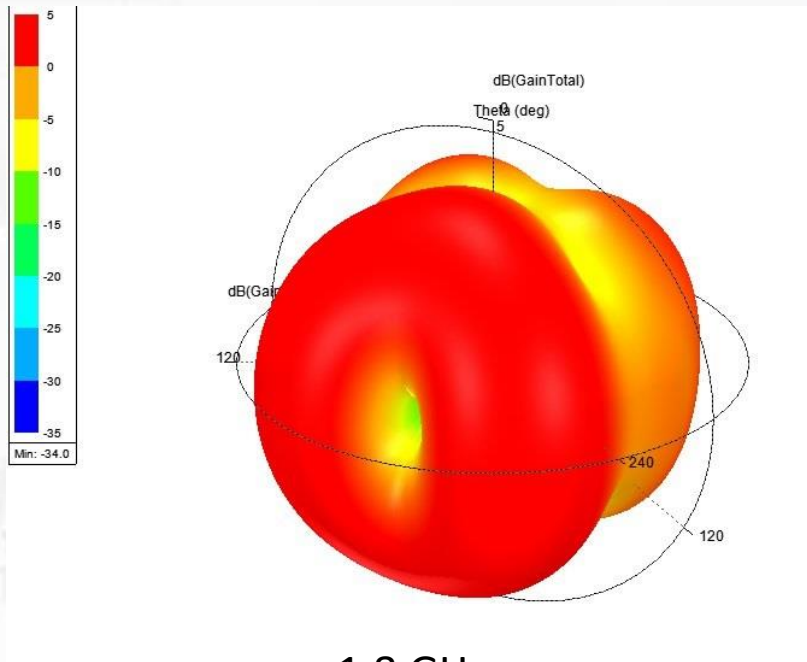

1.8 GHz

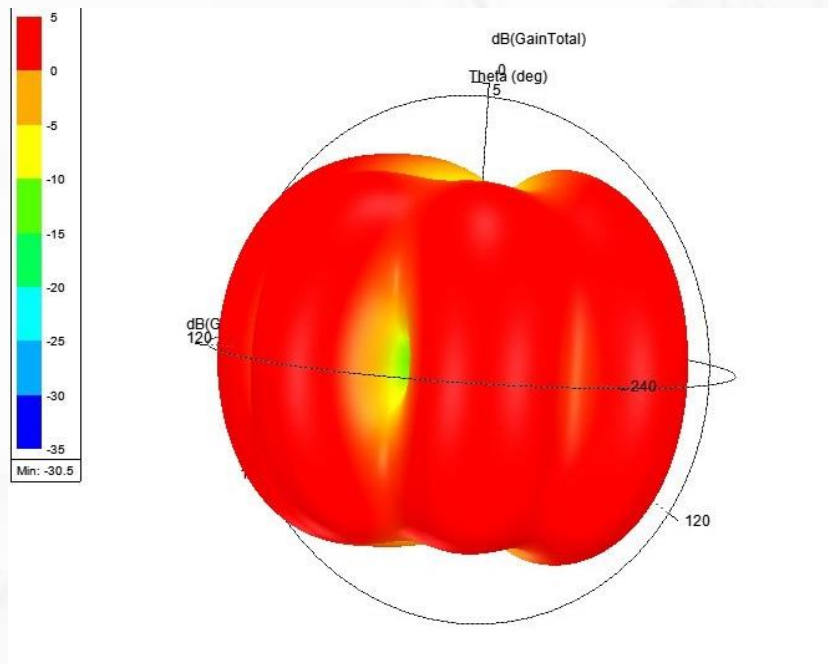

2.6 GHz

Maswell 5G/4G/LTE+GPS Panel Combo Antenna

AN_Master_001-3

Radiation pattern: high frequency

