

Low Noise Amplifier

ZX60-83LN+

50Ω 0.5 to 8 GHz

The Big Deal

- Extremely wideband, 0.5 to 8 GHz
- Low Noise, 1.4 dB @ 2 GHz
- High IP3, +34 dBm
- Excellent gain flatness ± 0.9 dB over 0.5 to 7 GHz @6V



CASE STYLE: GC957

Product Overview

Mini-Circuits' ZX60-83LN+ is a wideband low noise connectorized amplifier providing a unique combination of low noise figure, high IP3 and flat gain over a very wide frequency range, supporting a wide range of sensitive, high-dynamic range receiver applications and many systems where high performance over wideband is needed. This design operates on a single 5 or 6V supply and comes in a rugged, compact unibody case (0.74 x 0.75 x 0.46") with SMA connectors, making it an excellent candidate for tough operating conditions and crowded system layouts.

Key Features

Feature	Advantages
Ultra-wideband with excellent gain flatness, ± 0.9 dB	Enables a single amplifier to be used in a wide range of applications including WiFi, LTE, S-Band radar, C-band SATCOM, defense, instrumentation and more.
Low noise over the whole band	Enables lower system noise figure performance.
High gain, 21 dB typ.	Reduces the number of gain stages, lowering component count and overall system cost.
High IP3: <ul style="list-style-type: none"> • +35.2 dBm at 2 GHz • +28.5 dBm at 8 GHz 	The combination of low noise and high IP3 makes the ZX60-83LN+ ideal for use in low noise receiver front end (RFE) as it gives the user the advantages of sensitivity and two-tone IM performance at both ends of the dynamic range.
Low operating voltage, 5V/6V	The amplifier achieves high IP3 using low voltage.
Rugged, unibody construction	Mini-Circuits unibody construction integrates the RF connector into the case body, providing high reliability and excellent survivability in critical applications.

Notes

- A. Performance and quality attributes and conditions not expressly stated in this specification document are intended to be excluded and do not form a part of this specification document.
 B. Electrical specifications and performance data contained in this specification document are based on Mini-Circuit's applicable established test performance criteria and measurement instructions.
 C. The parts covered by this specification document are subject to Mini-Circuits standard limited warranty and terms and conditions (collectively, "Standard Terms"); Purchasers of this part are entitled to the rights and benefits contained therein. For a full statement of the Standard Terms and the exclusive rights and remedies thereunder, please visit Mini-Circuits' website at www.minicircuits.com/MCLStore/terms.jsp



Low Noise Amplifier

ZX60-83LN+

50Ω 0.5 to 8 GHz

Features

- Low Noise figure, 1.4 dB at 2 GHz
- High IP3, 35 dBm typ. at 2 GHz
- High Pout, P1dB 20.7 dBm typ. at 2 GHz and 6V
- Excellent Gain flatness, ± 0.9 dB over 0.5 to 7 GHz and 6V

Applications

- WiFi
- WLAN
- UMTS
- LTE
- WiMAX
- S-band Radar
- C-band Satcom



CASE STYLE: GC957

Connectors	Model
SMA	ZX60-83LN-S+

+RoHS Compliant

The +Suffix identifies RoHS Compliance. See our web site for RoHS Compliance methodologies and qualifications

Electrical Specifications at 25°C and 5V, unless noted

Parameter	Condition (GHz)	V _{DD} =6.0			V _{DD} =5.0	Units
		Min.	Typ.	Max.	Typ.	
Frequency Range		0.5		8.0	0.5-8.0	GHz
Noise Figure	0.5	—	1.6	—	1.6	dB
	2.0	—	1.4	1.7	1.4	
	4.0	—	1.5	—	1.5	
	8.0	—	2.2	—	2.2	
Gain	0.5	—	21.8	—	21.0	dB
	2.0	19.9	22.1	24.3	21.3	
	4.0	—	21.5	—	20.8	
	8.0	—	19.2	—	18.7	
Input Return Loss	0.5		14.2		13.1	dB
	2.0		15.0		15.0	
	4.0		12.0		11.0	
	8.0		6.1		6.1	
Output Return Loss	0.5		12.9		13.7	dB
	2.0		10.0		11.0	
	4.0		18.0		18.0	
	8.0		12.9		12.6	
Output Power at 1dB Compression ⁽¹⁾	0.5		18.6		16.3	dBm
	2.0		20.7		19.1	
	4.0		19.6		17.6	
	8.0		18.0		17.3	
Output IP3	0.5		34.2		29.7	dBm
	2.0		35.2		30.0	
	4.0		31.0		27.0	
	8.0		28.5		26.2	
Device Operating Voltage (V _{DD})			6.0	—	5.0	V
Device Operating Current (I _{DD})		—	77	94	60	mA
Device Current Variation vs. Temperature ²		—	-152	—	-109	μA/°C
Device Current Variation vs. Voltage			0.016		0.016	mA/mV
Thermal Resistance, junction-to-ground lead			47		47	°C/W

1. Current increases at P1dB to 109 mA typ. at +6V VDD and 88mA typ. at +5V VDD
 2. (Current at 85°C - Current at -45°C)/130

Notes

- A. Performance and quality attributes and conditions not expressly stated in this specification document are intended to be excluded and do not form a part of this specification document.
 B. Electrical specifications and performance data contained in this specification document are based on Mini-Circuit's applicable established test performance criteria and measurement instructions.
 C. The parts covered by this specification document are subject to Mini-Circuits standard limited warranty and terms and conditions (collectively, "Standard Terms"); Purchasers of this part are entitled to the rights and benefits contained therein. For a full statement of the Standard Terms and the exclusive rights and remedies thereunder, please visit Mini-Circuits' website at www.minicircuits.com/MCLStore/terms.jsp



Absolute Maximum Ratings⁴

Parameter	Ratings
Operating Temperature (ground lead)	-40°C to 85°C
Storage Temperature	-55°C to 100°C
Total Power Dissipation	0.95 W
Input Power (CW), Vd=5.6V	+19 dBm (5 minutes max.) +16 dBm (continuous)
DC Voltage	7 V

4. Permanent damage may occur if any of these limits are exceeded.
Electrical maximum ratings are not intended for continuous normal operation.

Outline Drawing

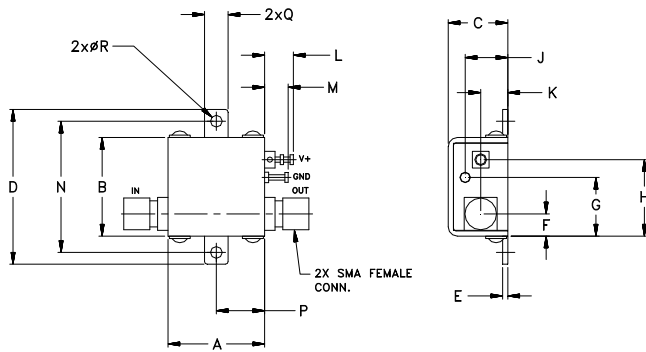

! NOTE: When soldering the DC connections, caution must be used to avoid overheating the DC terminal. See Application Note. [AN-40-010](#).

Outline Dimensions (inch/mm)

A	B	C	D	E	F	G	H	J	K	L	M	N	P	Q	R	wt
.74	.75	.46	1.18	.04	.17	.45	.59	.33	.21	.22	.18	1.00	.37	.18	.106	grams
18.80	19.05	11.68	29.97	1.02	4.32	11.43	14.99	8.38	5.33	5.59	4.57	25.40	9.40	4.57	2.69	23.0

Notes

- A. Performance and quality attributes and conditions not expressly stated in this specification document are intended to be excluded and do not form a part of this specification document.
- B. Electrical specifications and performance data contained in this specification document are based on Mini-Circuit's applicable established test performance criteria and measurement instructions.
- C. The parts covered by this specification document are subject to Mini-Circuits standard limited warranty and terms and conditions (collectively, "Standard Terms"); Purchasers of this part are entitled to the rights and benefits contained therein. For a full statement of the Standard Terms and the exclusive rights and remedies thereunder, please visit Mini-Circuits' website at www.minicircuits.com/MCLStore/terms.jsp

FREQUENCY (MHz)	GAIN (dB)		DIRECTIVITY (dB)		VSWR (:1)				POWER OUT @ 1 dB COMPR. (dBm)		NF (dB)		IP3 (dBm)	
	5V	6V	5V	6V	5V		6V		5V	6V	5V	6V	5V	6V
					IN	OUT	IN	OUT						
500	20.95	21.71	5.67	5.59	1.52	1.60	1.45	1.67	16.84	19.32	1.60	1.57	31.05	34.61
600	21.26	22.00	5.01	4.96	1.22	1.53	1.17	1.62	17.55	20.05	1.46	1.44	31.43	35.54
800	21.42	22.14	4.60	4.61	1.07	1.63	1.12	1.73	18.50	20.70	1.36	1.34	31.75	36.32
1000	21.43	22.12	4.55	4.59	1.20	1.74	1.27	1.85	19.23	21.06	1.29	1.28	31.96	36.52
1500	21.28	21.96	4.79	4.85	1.41	1.92	1.47	2.04	20.08	21.68	1.32	1.31	36.35	38.37
2000	21.14	21.81	5.04	5.07	1.51	1.95	1.57	2.07	20.09	21.61	1.37	1.35	35.25	38.90
2600	20.92	21.60	5.47	5.45	1.50	1.79	1.53	1.89	19.79	21.14	1.52	1.50	33.23	38.19
3000	20.85	21.55	5.60	5.52	1.47	1.56	1.47	1.65	19.09	20.40	1.54	1.54	30.16	35.44
3600	20.84	21.55	5.65	5.49	1.57	1.27	1.53	1.33	18.00	19.67	1.59	1.55	29.93	35.24
4000	20.75	21.47	5.87	5.67	1.69	1.11	1.62	1.14	17.45	19.23	1.56	1.54	28.69	33.05
4600	20.58	21.28	6.30	6.10	1.87	1.13	1.80	1.07	18.21	19.70	1.56	1.55	29.82	35.40
5000	20.50	21.18	6.56	6.37	1.94	1.21	1.87	1.16	18.21	19.59	1.59	1.57	27.84	32.02
6000	20.58	21.19	6.65	6.55	1.82	1.30	1.77	1.24	19.13	20.02	1.55	1.53	29.00	33.37
7000	20.35	20.90	7.36	7.32	1.62	1.35	1.59	1.29	18.89	19.61	1.90	1.87	29.40	33.74
8000	19.21	19.74	9.61	9.55	2.72	1.56	2.69	1.51	17.10	17.86	2.21	2.21	26.87	29.89

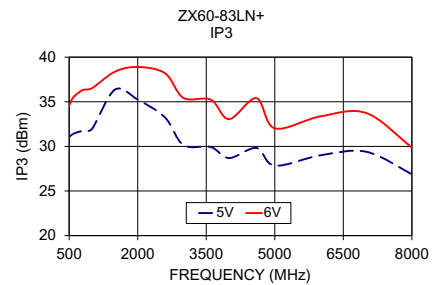
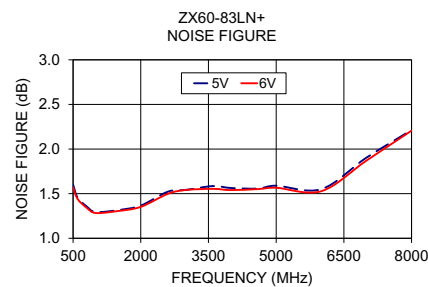
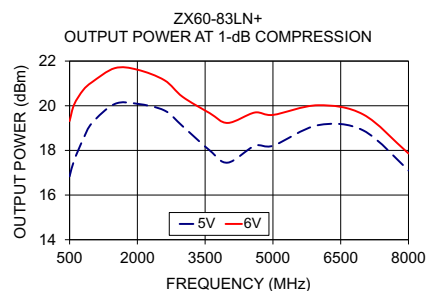
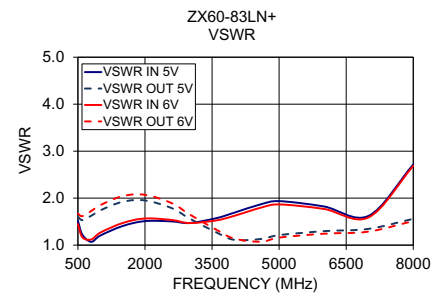
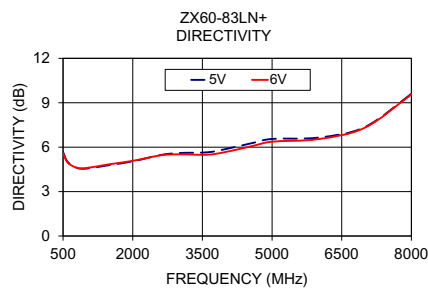
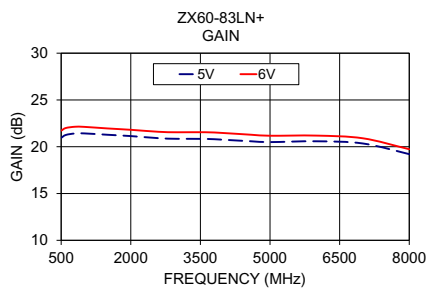

Notes

- A. Performance and quality attributes and conditions not expressly stated in this specification document are intended to be excluded and do not form a part of this specification document.
- B. Electrical specifications and performance data contained in this specification document are based on Mini-Circuit's applicable established test performance criteria and measurement instructions.
- C. The parts covered by this specification document are subject to Mini-Circuits standard limited warranty and terms and conditions (collectively, "Standard Terms"); Purchasers of this part are entitled to the rights and benefits contained therein. For a full statement of the Standard Terms and the exclusive rights and remedies thereunder, please visit Mini-Circuits' website at www.minicircuits.com/MCLStore/terms.jsp

